

Network Video Recorder

NVR301-S3-P Series



Key Features

- Support Ultra265/H.265/H.264 video formats
- 4/8-channel input
- Plug & Play with 4/8 independent PoE network interfaces
- Third-party IP cameras supported with ONVIF conformance: Profile S, Profile G, Profile T
- Support 1-ch HDMI, 1-ch VGA
- Up to 4K resolution recording
- 1 SATA HDDs, up to 6 TB
- Support cloud upgrade

Specifications

Model	NVR301-04S3-P4	NVR301-08S3-P8
Video/Audio Input		
IP Video Input	4-ch	8-ch
Network		
Incoming Bandwidth	64Mbps	
Outgoing Bandwidth	48Mbps	
Remote Users	128	
Protocols	P2P, UPnP, NTP, DHCP, PPPoE	
Video/Audio Output		
HDMI/VGA Output	HDMI: 3840x2160/30Hz, 1920x1080p/60Hz, 1920x1080p/50Hz, 1600x1200/60Hz, 1280x1024/60Hz, 1280x720/60Hz, 1024x768/60Hz VGA: 1920x1080p/60Hz, 1920x1080p/50Hz, 1600x1200/60Hz, 1280x1024/60Hz, 1280x720/60Hz, 1024x768/60Hz	
Recording Resolution	4K/5MP/4MP/3MP/1080p/960p/720p/D1/2CIF/CIF	
Audio Output	1-ch, RCA	
Synchronous Playback	4-ch	8-ch
Corridor Mode Screen	3/4	3/4/5/7/9
Decoding		
Decoding format	Ultra265/H.265/H.264	
Live view/Playback	4K/5MP/4MP/3MP/1080p/960p/720p/D1/2CIF/CIF	
Capability	1 x 4K@30, 4 x 5MP@25, 4 x 4MP@25, 4 x 3MP@25, 4 x 1080p@30	1 x 4K@30, 4 x 5MP@25, 4 x 4MP@25, 4 x 3MP@25, 4 x 1080p@30, 8 x 720p@30
Hard Disk		
SATA	1 SATA interfaces	
Capacity	Up to 6TB for each disk	
Smart		
VCA Detection	Face detection, Intrusion detection, Cross line detection, Audio detection	
VCA Search	Face search, Behavior search	
External Interface		
Network Interface	1 RJ-45 10M/100Mself-adaptive Ethernet Interface	
USB Interface	Rear panel: 2 x USB2.0	
PoE		
Interface	4 RJ-45 10M/100Mself-adaptive Ethernet Interface	8 RJ-45 10M/100Mself-adaptive Ethernet Interface
Max Power	Max 30W for single port Max 54W in total	Max 30W for single port Max 75W in total
Supported Standard	IEEE 802.3at, IEEE 802.3af	
General		
Power Supply	48V DC Power Consumption: ≤9 W (without HDD)	52V DC Power Consumption: ≤9 W (without HDD)
Working Environment	-10°C~+ 55°C (+14°F~+131°F), Humidity ≤ 90% RH (non-condensing)	
Dimensions (W×D×H)	260mm ×240mm × 46 mm (10.2" × 9.4" ×1.8")	
Weight (without HDD)	≤1.1kg (2.43lb)	

Dimensions

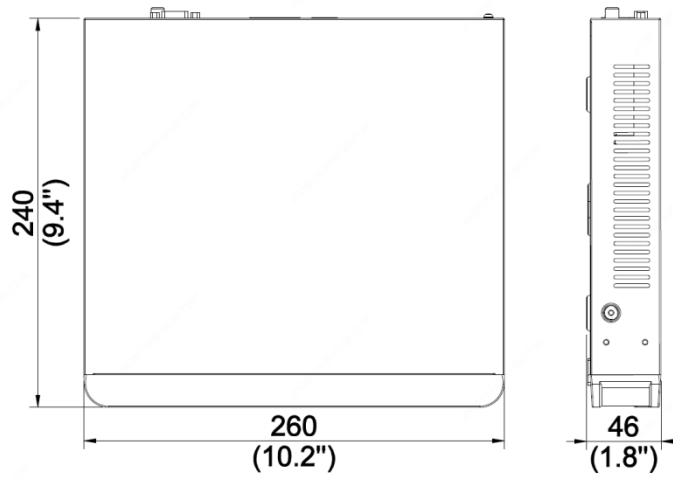

Rear Panel

Take **NVR301-04S3-P4** for example

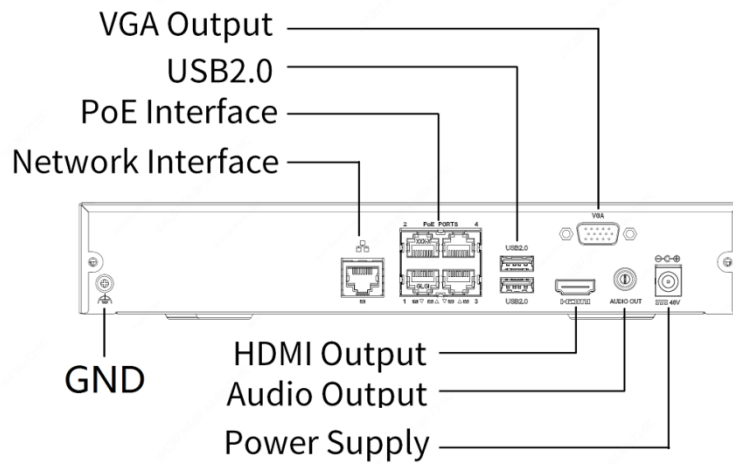

Zhejiang Uniview Technologies Co., Ltd.

Building No.10, Wanlun Science Park, Jiangling Road 88, Binjiang District, Hangzhou, Zhejiang, China

Email: overseasbusiness@uniview.com; globalsupport@uniview.com

<http://sgcdn.uniview.com>

©2020 Zhejiang Uniview Technologies Co., Ltd. All rights reserved.

* Product specifications and availability are subject to change without notice.