

IPC-T220H-U 2 MP IR Fixed Turret Network Camera



- 1/2.8" Progressive Scan CMOS
- 1920 × 1080@30fps
- 2.8/4 mm fixed lens
- Color: 0.028 Lux @ (F2.0, AGC ON), 0 Lux with IR
- H.265+/H.265/H.264+/H.264
- BLC/3D DNR/ROI
- IR range: Up to 30 m
- 3-Axis adjustment
- IP66
- Built-in microphone

Specifications

Camera	
Image Sensor	1/2.8" Progressive Scan CMOS
Min. Illumination	Color: 0.028 Lux @ (F2.0, AGC ON), 0 Lux with IR
Shutter Speed	1/3 s to 1/100,000 s
Slow Shutter	Yes
Day & Night	IR Cut Filter
WDR	DWDR
Angle Adjustment	Pan: 0° to 360°, tilt: 0° to 75°, rotate: 0° to 360°
Lens	
Lens Type	Fixed lens, 2.8/4 mm
Aperture	F2.0
FOV	2.8mm: Horizontal FOV: 114°, vertical FOV: 62°, diagonal FOV: 135° 4 mm: Horizontal FOV: 86°, vertical FOV: 46°, diagonal FOV: 102°
Lens Mount	M12
Illuminator	
IR Range	Up to 30 m
Wavelength	850 nm
Video	
Max. Resolution	1920 × 1080
Main Stream	50Hz: 25fps (1920 × 1080, 1280 × 960, 1280 × 720) 60Hz: 30fps (1920 × 1080, 1280 × 960, 1280 × 720)
Sub Stream	50Hz: 25fps (640 × 480, 640 × 360, 320 × 240) 60Hz: 30fps (640 × 480, 640 × 360, 320 × 240)
Video Compression	Main stream: H.265+/H.265/H.264+/H.264 Sub-stream: H.265/H.264/MJPEG
H.264 Type	Baseline Profile/Main Profile/High Profile
H.265 Type	Main Profile
Video Bit Rate	32 Kbps to 8 Mbps
Audio(-U)	
Audio Compression	G.711/G.722.1/G.726/MP2L2/PCM
Audio Bit Rate	64Kbps(G.711)/16Kbps(G.722.1)/16Kbps(G.726)/32-192Kbps(MP2L2)
Smart Feature-Set	
Basic Event	Motion detection, video tampering alarm, exception (illegal login)
Linkage Method	Upload to FTP, notify surveillance center, send email, trigger capture
Region of Interest	1 fixed region for main stream and sub-stream
Image	
Image Enhancement	BLC, 3D DNR
Image Setting	Rotate mode, saturation, brightness, contrast, sharpness, AGC and white balance adjustable by client software or web browser

Day/Night Switch	Day/Night/Auto/Schedule
Network	
Protocols	TCP/IP, ICMP, HTTP, HTTPS, FTP, DHCP, DNS, RTP, RTSP, RTCP, NTP, IGMP, QoS, UDP
API	ONVIF (PROFILE S, PROFILE G), ISAPI, SDK
Simultaneous Live View	Up to 6 channels
User/Host	Up to 32 users, 3 levels: administrator, operator and user
Client	HiLookVision PC Client, HiLookVision App
Web Browser	IE8+, Chrome 41.0-44, Firefox 30.0-51, Safari 8.0-11
Interface	
Communication Interface	1 RJ45 self-adaptive Ethernet port
Audio	1 audio input (built-in microphone), mono sound
Interface Style	Pigtail style interface
General	
Firmware Version	5.5.83
General Function	One-key reset, heartbeat, mirror, password protection, privacy mask, watermark, IP address filter
Reset	Reset via web browser and client software
Startup and Operating Conditions	-30 °C to 60 °C (-22 °F to 140 °F), humidity 95% or less (non-condensing)
Storage Conditions	-30 °C to 60 °C (-22 °F to 140 °F), humidity 95% or less (non-condensing)
Power Supply	12 VDC ± 25%, Φ 5.5 mm coaxial power plug; PoE (802.3af, class 0)
Power Consumption and Current	12 VDC, 0.4 A, max. 5 W; PoE (802.3af, 36 V to 57 V), 0.20 A to 0.10 A, max. 6.5 W
Material	Camera body: metal, bottom base : plastic
Dimensions	Camera: 95 × Φ110 mm (3.7" × Φ4.3") With package: 150 × 150 × 141 mm (5.9" × 5.9" × 5.6")
Weight	Camera: Approx. 355 g (0.78 lb.) With package: Approx. 684 g (1.5 lb.)
Approval	
EMC	47 CFR Part 15, Subpart B; EN 55032: 2015, EN 61000-3-2: 2014, EN 61000-3-3: 2013, EN 50130-4: 2011 +A1: 2014; AS/NZS CISPR 32: 2015; ICES-003: Issue 6, 2016; KN 32: 2015, KN 35: 2015
Safety	UL 60950-1, IEC 60950-1:2005 + Am 1:2009 + Am 2:2013, EN 60950-1:2005 + Am 1:2009 + Am 2:2013, IEC/EN 60950-1
Chemistry	2011/65/EU, 2012/19/EU, Regulation (EC) No 1907/2006
Protection	Ingress protection: IP66 (IEC 60529-2013)

* Listed resolutions are only selectable options. It does not mean that all streams can work at their maximum resolution at the same time.

Available Model

IPC-T220H-U (2.8/4 mm)

Dimension

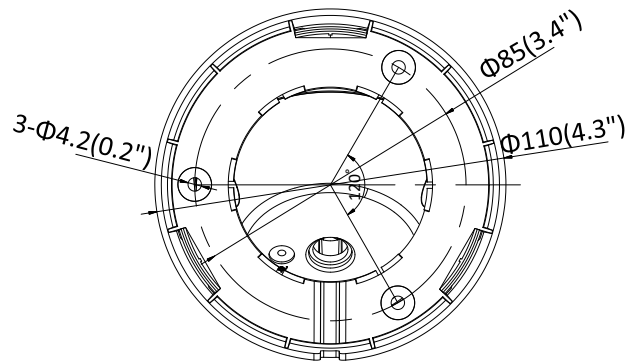
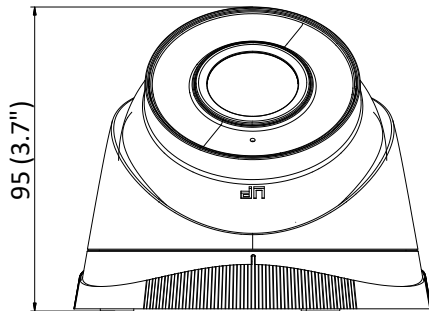

Unit: mm (inch)

Accessory



HIA-B401-110T
Wall Mount



HIA-B301
Vertical Pole Mount



HIA-B201
Corner Mount



HIA-J102
Junction Box